

# Product User Guide

# PRO SHORE

Title: **Pipe Lifter**

Issue: **1**

Date: **Jan 19'**

## Introduction:

This user guide is intended to provide basic information for users of the ProShore Pipe Lifter and to draw the client's attention to the practical aspects of handling and use which need to be considered in compiling a safe system of work. In particular, the client's attention is drawn to the size and weights of the individual components and the need for planning the lifting operations involved. All moving parts are mechanical and do not require the excavator to have additional hydraulics. The Pipe Lifter is only intended for use in lifting and laying of concrete pipes and is not to be used for any other purposes. The Pipe Lifter comes under the LOLER regulations and should not be used without a valid 6 monthly inspection certificate and should always be inspected before use.

## 2. Design

The Pipe Lifter is designed in accordance with:-

- EN ISO 12100-1 - Safety of machinery; Basic concepts, general principles for design,- Part 1: Basic terminology, methodology
- EN ISO 12100-2 - Safety of machinery; basic concepts, general principles for design; - Part 2: principles and specifications
- EN ISO 13857 - Safety of machinery - Safety distances to prevent hazard zones being reached by upper & lower limbs
- EN 349 - Minimum distance to avoid squeezing any parts of the body
- CE marked in accordance with EC Machinery Directive 2006/42/EC.

## 3. Component Identification

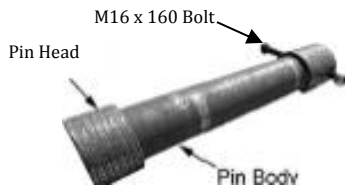

Code	Pin Dia. (mm)	Pin Head Dia	Overall Length (mm)	Weight (kg)
0070-0090-310	65	80	485	14.2

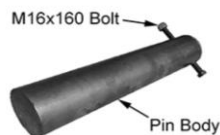

Code	Pin Dia. (mm)	Overall Length (mm)	Weight (kg)
0070-0090-300	65	485	12.7
0070-0090-320	80	485	18.7
0070-0090-330	90	650	43.1

Universal Quick Hitch Bracket

Quick Hitch Bracket (See Section 5 for details)

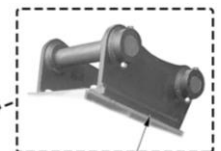

Quick Hitch Bracket (Accommodates Pin Dia. 90mm)

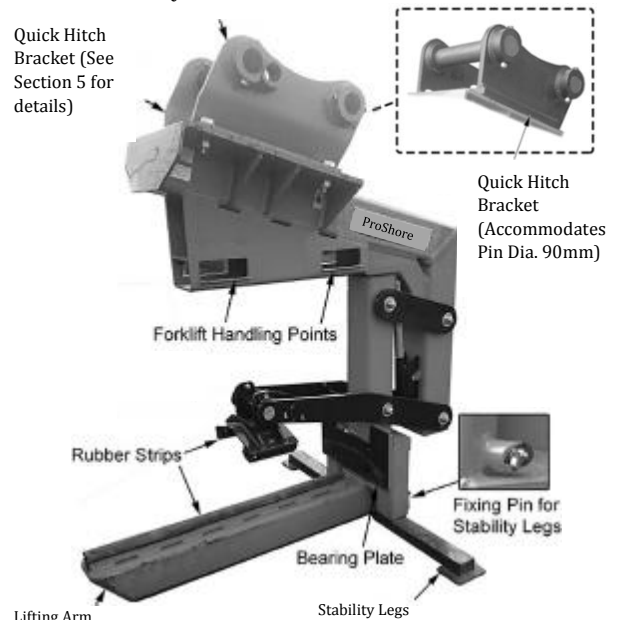

Code	Carrying Capacity (kg)		Internal Pipe Dia (mm)		Max Pipe Length (mm)	Pipe Lifter Size (mm)			Weight (kg)
	Min	Max	Min	Max		Height	Length	Width	
0070-0090-*	600	4000	300	1200	2600	2300	1740	1500	990
0070-0090-*	600	4000	300	1200	2600	2300	1740	1500	1075

Title:

Pipe Lifter

Issue:

1

Date:

Jan 19'

Contents

Page 1 : Introduction, Design, Component Identification,

Page 3 : Excavator Compatibility, Safety Features, How to Use,

Page 4 : Handling and Transportation, Storage and Maintenance,

Page 5 : Tools, Do's and Don'ts, General

*Appendix A: Warning, Examples of Damage*

**Warning:** Damage can occur to the Pipe Lifter if incorrectly used or the concrete pipe is incorrectly positioned - Refer to Appendix A and section 10 for further details.

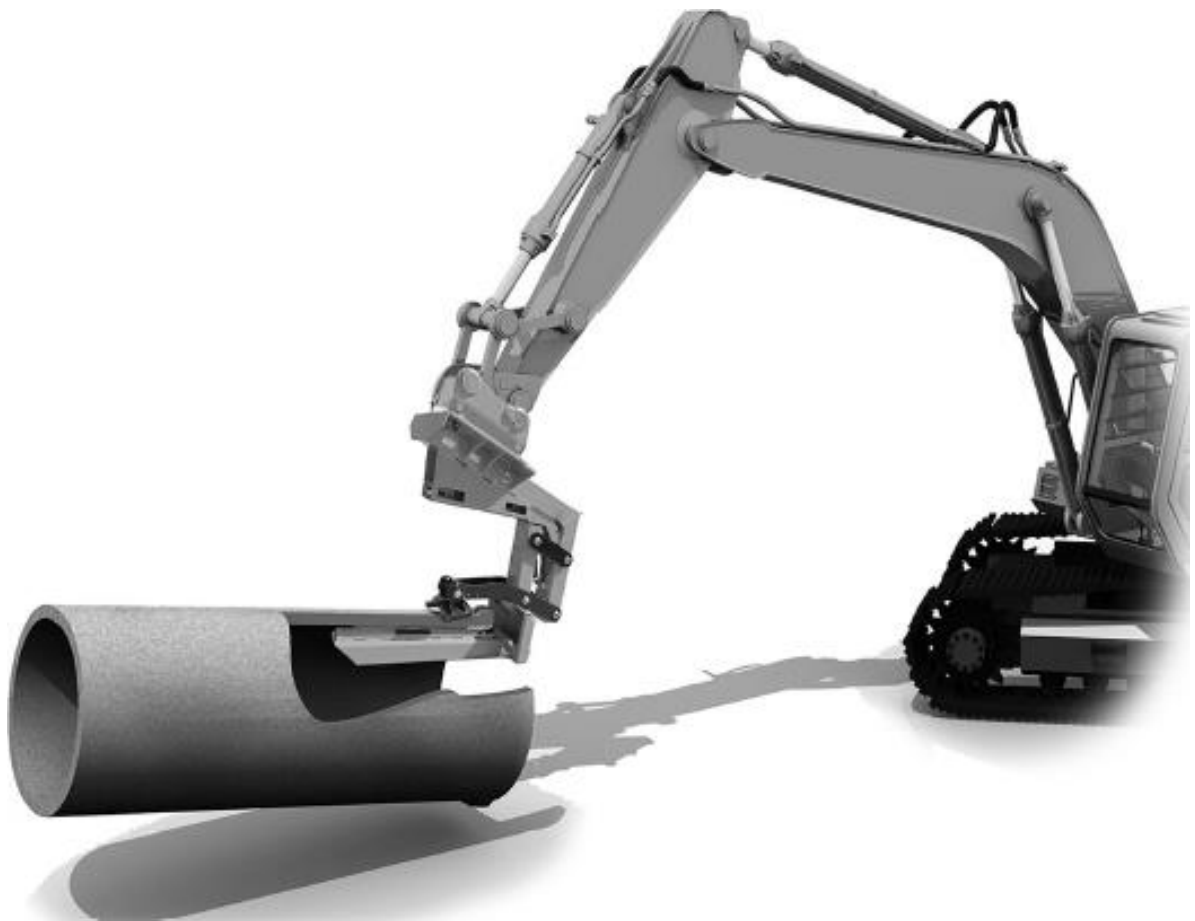

Acknowledgment;

This document has been compiled using extracts from the Probst User Manual and the Probst Product Flyer.

## 4. Excavator Compatibility

The two different types of Pipe Lifter stated in section 3 can be used to accommodate any type of excavator with a certain Pin Diameter, Pin centre, or Dipper Arm Width (please see the following table for further details).

**Note:** Before use, ensure that the correct Pipe Lifter has the correct diameter Quick Hitch Pins installed in the Quick Hitch Bracket, (refer to ProShore for further details).

Pipe Lifter Code	Dipper Arm Width (mm)	Pin Dia (mm)	Pin Centres (mm)	Pin Codes	Pin Qty
0070-0090	330 or less	65	380	0070-0090-300 0070-0090-310	1 Each
		80	465	0070-0090-320	2
0070-0090	442 or Less	90	552	0070-0090-330	2

**Note:** The quick Hitch is captive to each Pipe Lifter so **CANNOT** be altered, if a different excavator is required, please contact your ProShore Representative.

## 5. Safety Features

- Saves time in off-loading and installation.
- Ground Workers are not required in the trench during actual pipe installation

## 6. How to Use

- Prior to attaching the Pipe Lifter on to the excavator make sure that the correct Quick Hitch Bracket Pins are installed and the Stability Legs are perpendicular to the lifting arm as shown in section 3.
- Prior to lifting any pipes ensure that the Clamping Bracket is in the correct position to suit the concrete pipe size being lifted, (see section 6.1 for details on adjusting the Clamping Bracket). If lifting at the preferred female end of the concrete pipe the Clamping Bracket should be placed close to the collar and not on it (see fig 6, section 10 for more details).
- Ensure that all personnel are clear of the Pipe Lifter. Safely and correctly attach the excavators' Quick Hitch to the quick Hitch Bracket, as shown in section 3. Ensure that the excavators' quick hitch is in the locked position before use.
- Once the quick hitch is connected to the Pipe Lifter and it is suspended in its working position, release the Fixing Pin that secures the Stability Legs by pulling and rotating the handle. Reposition both legs parallel to the lifting arm to ensure that the stability legs do not foul the sides of the excavation.
- The lifting arm of the Pipe Lifter can then be placed fully inside the pipe and then carefully lifted, when this is taking place the Clamping Arm should slowly clamp down on top of the pipe and the rubber strips will hold it in position (see fig. 1 ).
- Lift the pipe into the desired position making sure to keep the pipe horizontal while moving.
- Lower the pipe onto the ground to release the clamp.
- Slowly retract the Pipe Lifter from the pipe.
- Once all lifting has been carried out, re-position both Stability Legs so that they are perpendicular to the lifting arm. Then place on flat, stable ground and detach the excavators Quick Hitch.



All personnel **MUST** be clear of the pipe and pipe lifter with in use. Failure to do so can result in serious injury.



Immediately stop using the Pipe Lifter if any damage is seen or occurs during usage. Contact ProShore immediately and remove Pipe Lifter from use, refer to Appendix A2 for examples of damage to look out for.



Fig. 1

### 6.1 Clamping Bracket Adjustment

To adjust clamping bracket:-

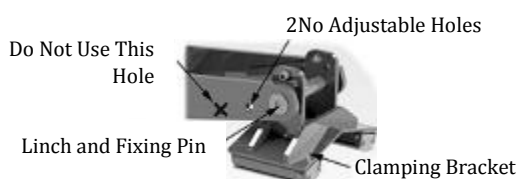

Fig. 3

- Remove the linch pin and slide out the fixing pin, as shown in Figure 3
- Reposition the Clamping Bracket to the correct position by selecting the correct adjustment hole, i.e. the hole that ensures the Clamping Bracket is tight against the collar at the female end of the concrete pipe (see fig 6, section 10 for details).
- Once in position replace the fixing pin and secure it in place with the linch pin.

**Note:** Clamping bracket must be able to rotate freely

Title: **Pipe Lifter**

Issue: **1**

Date: **Jan 19'**

## 7. Handling and Transportation

Note: Stability Legs **MUST** be perpendicular to the lifting arm during transportation.

- Weights of components are given in Section 3.
- Suitable lifting equipment of adequate lifting capacity should be provided for handling.
- Slings should always be carried out by suitably experienced and competent personnel.
- The Pipe Lifter **MUST** always be securely restrained to the vehicle bed during transportation, using the Forklift Handling points as strapping points.
- To aid off-loading on site it is recommended to position the Pipe Lifter at the rear of the wagon with the Quick Hitch Bracket facing towards the headboard (see Fig. 4).
- Return equipment as supplied from the ProShore depot.

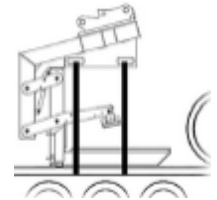

### 7.1 Lifting Points

The Pipe Lifter can be safely lifted using one of two methods. One method is by using the quick hitch connection point on the excavator as shown in 7.1.1 (see section 5 for details). The second method, as shown in 7.1.2 below, is to use a forklift truck to lift the Pipe Lifter using the forklift handling points (as shown in section 3).

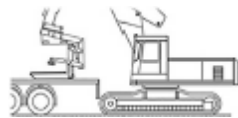

7.1.1 Using an excavator to load/offload



7.1.2 Using a forklift truck to load/offload

## 8. Storage and Maintenance

### 8.1 Storage

- When not in use the Pipe Lifter should be stored on stable flat ground in an easily accessible environment, together with the User Guide and any other instructions relating to its use.

### 8.2 Maintenance

- Before any inspection or maintenance takes place ensure the Pipe Lifter is on stable flat ground and the stability legs are perpendicular to the lifting arm, ensuring that all areas of the Pipe Lifter can be accessed easily and safely. All maintenance/inspections that are carried out must be carried out and recorded by a competent person. (Refer to Proof of Maintenance Form).

#### Before each Startup:

- Check the Clamping Arm, Clamping Bracket and Lifting Arm for mobility and abrasion. All damaged parts **MUST** be replaced.
- All parts to be cleaned with a high pressure cleaner, care must be taken to remove dirt and grit from the device, particularly around all moving parts and the rubber strips. Note: Components which have become wet during cleaning or use may only be dried naturally, not near a fire or similar heat sources.
- Check ALL bolts and nuts for tightness.

#### Weekly:

- Apply grease to all moving parts, (making sure not to contaminate any rubber strip, see section 3).

#### 6 Monthly:

- ALL components **MUST** be inspected and certified under the LOLER regulations every 6 months.
- Check all moving parts, bolts, struts and Stability Legs. Check for corrosion and safety.
- The service life of the Pipe Lifter must be determined in the 6 monthly inspection.

#### General:

- All parts should be visually inspected for damage, which would include:
  - bent or distorted plates or sections
  - dents, tears or holes in any plates, sections or rubber
  - Missing Items

**Note:** If damage is found to any component, remove item from use and contact ProShore immediately

## 9. Tools

- 13mm Spanner for M8 Bolts

## 10. Do's and Don'ts

- DO .. ensure the correct position of the Pipe and Clamping Bracket is always used, (see Fig. 6 and Appendix A1)
- DO .. ensure that the Stability Legs are perpendicular to the lifting arm when not being used and parallel to the lifting arm when attached to the excavator.
- DO .. ensure that all nuts and bolts are securely tightened. Use only recommended lock nuts.
- DO .. ensure the Pipe Lifter is securely restrained to the vehicle bed during transportation using the forklift handling points as strapping points, (see Fig 8).
- DO .. check the Pipe Lifter before and after each use for damage.
- DO.. immediately stop using a damaged Pipe Lifter and remove from use, see Appendix A2 for damage details.
- DO .. ensure that ALL personnel are a safe distance from the Pipe Lifter and pipe when in use.
- DO .. ensure that the Pipe Lifter is correctly attached to the excavator and that the quick hitch is in the locked position before any lifting takes place.
- DO .. ensure that all moving parts are adequately greased.
- DO .. ensure that a risk assessment and safe system of work are available prior to any lifting taking place.
- DO .. ensure the pipe surfaces in contact with the Pipe Lifter are free from any dirt/ lubricant/ grease.
- DO.. ensure that the excavator operator has a clear view of the Pipe Lifter at all stages of the lift.
- DO .. ensure that ALL personnel have an overview of the Pipe Lifter at all times when in use.
- DO .. ensure that the pipe is kept horizontal at all times while being transported using the Pipe Lifter, (see Fig. 7)
- DO.. ensure the excavator is on stable ground prior to using the Pipe Lifter.

- DO NOT.. use the Pipe Lifter in temperatures less than 3°C (37.5°F).
- DO NOT.. lift any pipes without checking that the Clamping Bracket is set correctly for the pipe being lifted.
- DO NOT.. place any straps around the Gas Struts or Lifting Arms during transportation, (see Fig.8).
- DO NOT.. attempt to lift pipes with a diameter less than 300mm or greater than 1200mm when using the Pipe Lifter.
- DO NOT.. lift any pipe that weighs less than 600kg or more than 4000kg and that is longer than 2600mm.
- DO NOT.. apply any type of lubricant to the lifting area. This can cause the concrete pipe to slip out of the Pipe Lifter.
- DO NOT.. leave the excavator unattended while a pipe is being lifted.
- DO NOT.. touch any part of the pipe or Pipe Lifter when it is in use.
- DO NOT.. exceed the operating capacity of the excavator.
- DO NOT.. shake or jar the Pipe Lifter at any time.
- DO NOT.. store the Pipe Lifter on soft or uneven ground.
- DO NOT.. use the Pipe Lifter if any damage is found.
- DO NOT.. put any external forces onto the Pipe Lifter that would not occur during normal operations (i.e. do not use the Pipe Lifter to aid any manoeuvring of the excavator, see Fig. 5).
- DO NOT.. lift any load using the end of the Lifting Arm (ALL pipes MUST be tight against the Bearing Plate).

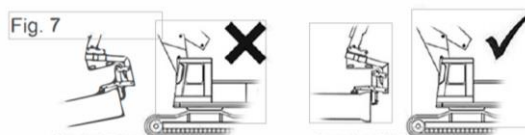
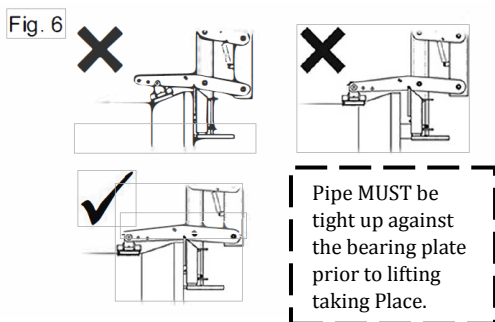
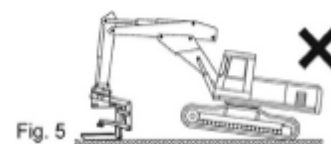

## 11. General

Since our policy is one of continual improvement, components may vary in detail from the descriptions given in this publication.

Appendix A1: Warning;

 It is advisable for the operator to keep a copy of this Appendix clearly visible while using the Pipe Lifter.

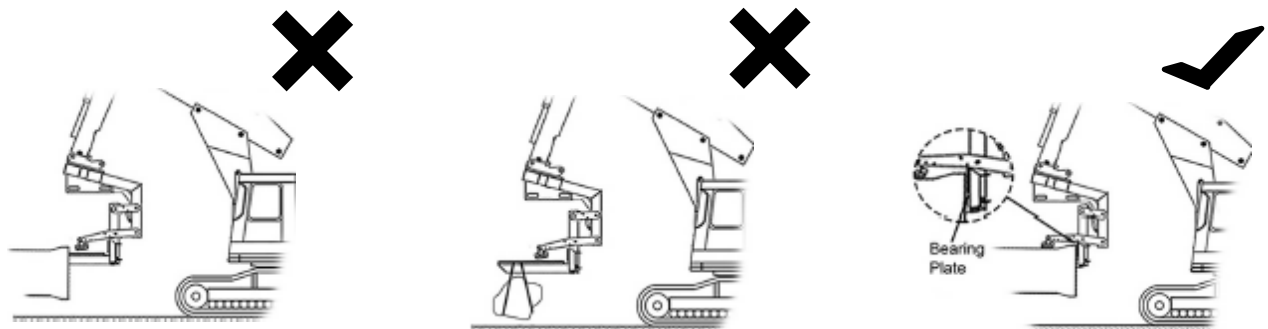

**WARNING:**  
Do NOT lift a pipe using the end of the Lifting Arm or use the end of the lifting arm to nudge / position a pipe.

**WARNING:**  
Do NOT use the Pipelifter to lift or move anything other than the stated concrete pipes - see section 3 in the User Guide.

**Note:**  
Always ensure the pipe is supported along the full length of the Lifting arm and up tight against the bearing plate.

Appendix A2: Examples of Typical Damage;

Following images show some examples of typical damage to the Pipe Lifter which will warrant the Pipe Lifter to be removed from service. Please note that any damage not covered below still has to be logged and reported to ProShore. If the damage stops the Pipe Lifter from being used safely STOP and remove the Pipe Lifter from service and contact your ProShore Representative immediately for assistance.



Damage to the End of the Rubber Strip.



Damage causing the Rubber Strip to come away from the Brackets.



Damage along the length of the Rubber Strip



Damage to the Stability legs causing the Pipe Lifter to become unstable.

 **WARNING:** STOP using the Pipe Lifter immediately if ANY damage is seen or occurs to the Pipe Lifter and remove from service. Contact your ProShore Representative immediately for assistance.

# Inspection Sheet/Report

# PRO SHORE

Title:

Pipe Lifter

Issue:

1

Date:

Jan 19'

## Proof of Maintenance Form

**Note:** The inspection of this product and completion of this form must only be carried out by persons trained and authorised to do so.

Name of inspector: \_\_\_\_\_

Pipe Lifter

On behalf of: \_\_\_\_\_

Unique Number: \_\_\_\_\_

Signature: \_\_\_\_\_

Date: \_\_\_\_\_

**Refer to section 8.2 for maintenance and inspection details. Contact ProShore if any damage is found and remove Pipe Lifter from use.**

### Before every use

- Carefully clean all components with water.
- Check all components for any abrasion or contamination.
- Check all components for any damage.
- Check all rubber strips are not worn or damaged (replace as required).
- Check movement of Clamping Arm and Clamping Bracket.
- Check all items are present, inc. stability legs, connection pins and rubber strips.
- Check all bolts and nuts are present and tight.
- Check Gas Cylinders are present and operating correctly.

Checked

### Weekly

- Lubricate all sliding components (device must be in a opened position prior to any lubrication being applied)

--

### 6 Monthly

- All components inspected and certified under the LOLER regulations.
- Hire products should be returned to ProShore for their report of thorough examination.
- Check all Cylinders, bolts and moving parts.
- Check for corrosion.
- Service life determined.
